



SURAT KLARIFIKASI

Saya yang bertanda tangan dibawah ini:

Nama : **Dr. Indar Chaerah Gunadin, ST.,MT**
NIP : 197311181998031001
NIDN : 0018117301
Pangkat/Gol./TMT : Pembina (Gol.IV/a) 1 Oktober 2012
Jab. Fungsional : Lektor Kepala
Unit Kerja : Fakultas Teknik Departemen Teknik Elektro UnHas

Dengan ini menyatakan bahwa karya ilmiah yang saya hasilkan dan digunakan untuk pengurusan kenaikan Jabatan Guru Besar adalah memiliki kebaruan dari sisi konten terhadap disertasi kami yang berjudul : *“Modelling of Load Characteristic, Tap Changer And Current Limiter for Steady State Stability Studi Using Combination Dimo Method with Artificial Intelligence”*

Adapun paper yang menjadi syarat khusus dalam pengajuan Guru Besar adalah:

1. *Forecasting Voltage Collapse when Large-Scale Wind Turbines Penetrated to Power Systems Using Optimally Pruned Extreme Learning Machines (OPELM) - Case Study: Electric Power System South Sulawesi-Indonesia.*
2. *Determination of stability index of electrical power system using REI-Dimo methods*
3. *The Impact of the Injection of Wind Power Plant on the Steady State Condition and the Dynamics of SULSELBAR Power System*

Analisa kebaruan:

1. **Paper-1** ini membahas terkait prediksi *Voltage Collapse* ketika wind turbine skala besar masuk ke sistem tenaga listrik menggunakan metode Optimally Pruned Extreme Learning Machines (OPELM). Ini sangat berbeda dengan konten disertasi kami, walaupun masih dalam satu tema besar yakni mengupas tentang masalah kestabilan sistem tenaga.
2. **Paper-2** ini membahas penentuan batas kestabilan sistem menggunakan REI-Dimo dengan kasus Sistem Sulbagsel dan dengan pendekatan metode simulasi menggunakan Simulink, untuk menampilkan batas kestabilan sistem. Hal ini yang tidak digarap pada disertasi kami, walaupun pada disertasi juga menggunakan metode REI-Dimo.
3. **Paper-3** ini membahas terkait dampak masuknya Wind Turbine dari sisi kestabilan transient, sangat berbeda dengan tema disertasi yang focus pada kestabilan steady state. Walaupun paper



KEMENTERIAN PENDIDIKAN, KEBUDAYAAN, RISET DAN TEKNOLOGI
UNIVERSITAS HASANUDDIN
FAKULTAS TEKNIK

Kampus Fakultas Teknik Unhas Jl. Poros Malino Km. 6, Bontomarannu, Gowa 92171, Sulawesi Selatan
Website <http://eng.unhas.ac.id>, E-mail: teknik@unhas.ac.id

dan disertasi ini sama-sama membahas tema terkait Stability, akan tetapi cabang kajian stability nya berbeda.

Demikianlah surat klarifikasi ini kami buat. Terima kasih atas kerjasamanya.

Makassar, 3 April 2023

Mengetahui,
Wakil Dekan I Fak. Teknik Unhas

Dr. Amil Ahmad Ilham, S.T.,M.IT.
NIP 197310101998021001

Yang Membuat Pernyataan,



Dr. Indar Chaerah Gunadin, ST.,MT
NIP 197311181998031001

See discussions, stats, and author profiles for this publication at: <https://www.researchgate.net/publication/261324542>

Steady-State Stability Assessment Using Neural Network Based on Network Equivalent

Article in TELKOMNIKA (Telecommunication Computing Electronics and Control) · December 2011

DOI: 10.112928/telkomnika.v8i3.731

CITATIONS

9

READS

290

4 authors, including:



Indar Gunadin

Universitas Hasanuddin

61 PUBLICATIONS 135 CITATIONS

[SEE PROFILE](#)



Muhammad Abdillah

Universitas Pertamina

113 PUBLICATIONS 336 CITATIONS

[SEE PROFILE](#)



Adi Soeprijanto

Institut Teknologi Sepuluh Nopember

223 PUBLICATIONS 1,209 CITATIONS

[SEE PROFILE](#)

Some of the authors of this publication are also working on these related projects:



Design Virtual Inertia based on Artificial Intelligence for Power System [View project](#)



Developing Safety Integrity Level (SIL) Study for Pertamina Refinery [View project](#)

Steady-State Stability Assessment Using Neural Network Based on Network Equivalent

Indar Chaerah Gunadin¹, Muhammad Abdillah², Adi Soeprijanto², Ontoseno Penangsang²

¹Institut Teknologi Sepuluh Nopember, Universitas Hasanuddin, Makasar, Indonesia

²Institut Teknologi Sepuluh Nopember, Surabaya, Indonesia

e-mail: indar09@mhs.ee.its.ac.id¹, abdillah@elect-eng.its.ac.id², adisup@ee.its.ac.id³,
ontoseno@yahoo.com⁴

Abstrak

Sistem tenaga di seluruh dunia mengalami peningkatan pada ukuran dan kompleksitas yang diakibatkan oleh pengembangan sistem interkoneksi secara luas. Situasi ini akan membawa sistem tenaga lebih sering beroperasi mendekati batas kestabilan steady-state yang berakibat pada peningkatan ketidakstabilan tegangan atau voltage collapse. Paper ini menjelaskan perbaikan Steady-state Stability Limit (SSSL) pada sistem tenaga menggunakan kombinasi metode REI-Dimo dan Artificial Neural Network (ANN). REI-Dimo equivalent digunakan untuk memperoleh indeks SSSL pada sistem tenaga. Selanjutnya hasil dari REI-Dimo akan diajarkan pada metode ANN secara on-line. Studi ini dilakukan pada sistem Jawa-Bali 500kV. Dari simulasi terlihat bahwa metode yang diusulkan dapat memprediksi SSSL pada sistem tenaga secara akurat. Metode melakukan perhitungan lebih efisien dan cocok digunakan untuk memonitor secara on-line kondisi kestabilan steady-state pada sistem tenaga.

Kata kunci: neural network, REI-Dimo, steady-state stability limit, voltage collapse

Abstract

Power systems in all over the world have increased in size and complexity due to rapid growth of widespread interconnection. This situation will make power system operated closer to steady-state stability limit (SSSL) resulting in higher probability voltage instability or voltage collapse. This paper presents SSSL assessment in power system using Artificial Neural Network (ANN) model based on REI-Dimo method. The equivalent REI-Dimo is used to determine SSSL index of the power systems. Then, the result of REI-Dimo will be taught on ANN method via online. Studies were carried out on a Java-Bali 500kV system. The simulation showed that the proposed method could accurately predict the proximity to SSSL in power system. The method was computationally efficient and suitable for online monitoring of steady-state stability condition in the power systems.

Keywords: neural network, REI-Dimo, steady-state stability limit, voltage collapse

1. Introduction

The growth of widely-opened transmission access has a significant side effect for modern utilities. Transmission system must accommodate real power transfers that can be quite different from those whose transmission networks are originally planned. The conditions as: parallel flows, network loadings and low bus voltages may be caused by energy transaction across multi area systems of continental or sub continental size. Under such deteriorated operating conditions, unstable conditions or blackouts due to instability which becomes possible if a major disturbance occurs in system, or if a large amount of real power is transferred across a stability of constrained transmission corridor, or even if an insignificant topology change, such as a minor line trip, happens in a system already operated near its maximum load ability limit [1].

Power systems in the modern competitive electric market have increased in size and complexity due to the rapid growth of widespread interconnection. More efficient use of transmission network has already led to situation in which many power systems are operated much longer and closer to steady-state stability limit resulting in a higher probability of collapse [2].

The steady-state stability limit (SSSL) of a power system is "a steady-state operating condition for which the power system is steady-state stable but an arbitrarily small change in any of the operating quantities in an unfavorable direction causes the power system to lose the stability". An earlier definition refers to this concept as "the stability of the system under the conditions of gradually or relatively slow changes in the load". Voltage collapse, units getting out of synchronism, and instability caused by self-amplifying small-signal oscillations are all forms of steady-state instability [3].

Empirically, the risk of steady-state instability is associated with low real or reactive power reserves, low voltage levels, and large bus voltage variations for small load or generated power changes. Recurring "temporary faults", i.e. where breakers trip without apparent reason and which is disconnected by a protection without being able to identify the fault, might also be an indication of steady-state instability. Breaker trips can happen when loads increase due to "balancing rotors" of generators that are operated near instability trip and then get back in synchronism[1]-[7].

Equivalent REI (Radial, Equivalent and Independent) has also been used to speed up and simplify the complex computational algorithms. For example, the rigorous solution of the steady-state stability problem is predicated on detailed machine model and entails an alternate sequence of load flow and eigenvalues calculating until the point of instability is found. However, determining eigenvalues for successively deteriorated load-flow cases is computationally intensive and has the inconvenience that load-flow may not converge near the instability. The use of equivalent in conjunction with appropriate simplifying assumptions is the only way to overcome such difficulties and Dimo's method has been successfully implemented and is currently used in several SCADA/EMS installations to compute the system load ability limits in real-time and to continuously monitor the distance to instability [8]-[9].

Recently, there has been considerable interest in the application of Artificial Neural Network (ANN) to power system [10-14]. ANN has the ability to classify complex relationships properly. The relationships classified by ANN are highly non-linear and often result from large mathematical models. Once trained, the ANN can classify new data much faster than it would be possible by solving the model analytically: An integrated based systems, ANN, and conventional power system solution methodologies have potential to provide real-time optimization and control of power system [10]-[11].

This paper presents the application of ANN to provide fast indication of steady stability limit with the use of REI-Dimo result as training data. For online steady-state stability monitoring, it is essential to identify the maximum power of loading faster calculation so that the ANN method can be an alternative solution.

2. Research Method

2.1. REI-Dimo Approach For Steady-State Stability Assessment

Many references that are available describe the approach to steady-state stability assessment developed by Paul Dimo, starting, of course, with the books and papers written by Dimo himself. In order to avoid overlap with already-published material, in this section we just briefly discuss just the key aspects of the technique and emphasize the assumptions that provide computational speed while preserving precision and accuracy. The theoretically oriented reader is directed to review reference [1,6], in which the more subtle aspects of Dimo's methodology are addressed in detail, including the generalization of Dimo's formulation of the reactive-power steady-state stability criterion.

A power system consists of a linear sub-system, i.e., transmission lines, transformers, reactor, capacitors, and the bus-to-ground admittances to represent line charging and transformer taps; and a non-linear subsystem, i.e., generators, loads and synchronous condensers. Bus can be divided into non-essential buses, which are to be eliminated, and essential buses, which are to be retained unchanged[1].

Figure 1, which meets the requirement that the generators be radially connected to a "nodal point" where the load is located. The topology of this network, in spite of its simplicity, reflects a typical radial network of short-circuit impedances (admittances) obtained after applying the short circuit current transformation [1].

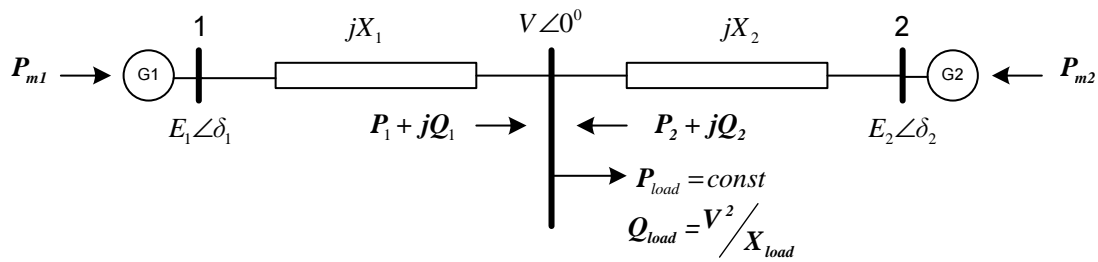

Figure 1. Radial network of generators connected to the nodal point

The generators G_1 and G_2 the mechanical powers P_{m1} and P_{m2} equal the electrical MW generated powers, which are given by equations (1) and (2):

$$P_{m1} = P_1 = \frac{E_1 V}{X_1} \sin \delta_1 \quad (1)$$

$$P_{m2} = P_2 = \frac{E_2 V}{X_2} \sin \delta_2 \quad (2)$$

The generated real powers are entirely absorbed by the load P_{load} , as shown in equation (3):

$$P_{load} = \frac{E_1 V}{X_1} \sin \delta_1 + \frac{E_2 V}{X_2} \sin \delta_2 = const \quad (3)$$

And the reactive power of the load Q_{load} is supplied by:

$$Q_{load} = \frac{V^2}{X_{load}} = \frac{E_1 V}{X_1} \cos \delta_1 - \frac{V^2}{X_1} + \frac{E_2 V}{X_2} \cos \delta_2 - \frac{V^2}{X_2} \quad (4)$$

Let us now consider a perturbation ΔQ of reactive power injected into the load bus. From (1), (2), (3), and (4) and with $\Delta P_{m1} = 0$, $\Delta P_{m2} = 0$, $\Delta P_{load} = 0$, as well as $\frac{\partial Q_{load}}{\partial \delta_1} = 0$ and $\frac{\partial Q_{load}}{\partial \delta_2} = 0$ because Q_{load} is a function of V only, we obtain Jacobian matrix of the system [1]:

$$J = \begin{bmatrix} \frac{\partial P_1}{\partial V} & \frac{\partial P_1}{\partial \delta_1} & 0 \\ \frac{\partial (P_1 + P_2)}{\partial V} & \frac{\partial (P_1 + P_2)}{\partial \delta_1} & \frac{\partial (P_1 + P_2)}{\partial \delta_2} \\ \frac{\partial (Q_1 + Q_2 - Q_{load})}{\partial V} & \frac{\partial (Q_1 + Q_2)}{\partial \delta_1} & \frac{\partial (Q_1 + Q_2)}{\partial \delta_2} \end{bmatrix} \quad (5)$$

Then, we obtain the determinant D of Jacobian matrix:

$$D = (I_1 \cos \delta_1)(I_2 \cos \delta_2) V^2 \left(\frac{I_1}{\cos \delta_1} + \frac{I_2}{\cos \delta_2} - 2YV \right) \quad (6)$$

The solution will get if, and only if, $D \neq 0$, in which case we obtain

$$\frac{d\Delta Q}{d\Delta V} = \frac{I_1}{\cos \delta_1} + \frac{I_2}{\cos \delta_2} - 2YV \quad (7)$$

Paul Dima has shown that, for system of 1,..., m generators and synchronous condenser connected radially to a single-load bus (either actual or equivalent) through the admittance $Y_1, \dots, Y_i, \dots, Y_m$, the derivative can be computed with formula [1]:

$$\frac{d\Delta Q}{dV} = \sum_m \frac{Y_m E_m}{\cos \delta_m} - 2 \left(\sum_m Y_m + Y_{load} \right) V \tag{8}$$

in which:

E_m = internal voltages of the machines (assumed to remain constant, unaffected by small adjustments made under steady-state stability conditions)

δ_m = internal angles of the machines with reference to the voltage V on the load bus (either fictitious or actual)

V = Voltage in the load center

Y_{Load} = Load center admittance

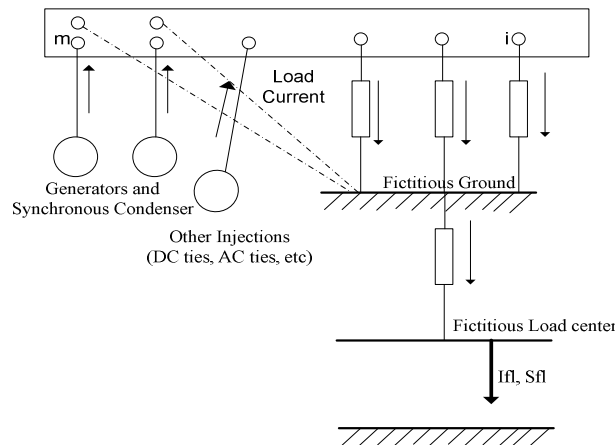

Figure 2. Transition from the meshed power system network to radial scheme

to simplify, the formula in equation (8) will be separated by two components, such as:

$$D = \sum_m \frac{Y_m E_m}{\cos \delta_m} \quad \text{and} \quad E = 2 \left(\sum_m Y_m + Y_{load} \right) V \tag{9}$$

To determine the pattern of economic relations to be represented on the stability index value, $d\Delta Q/dV$ is determined by changes in the parameters V and $\cos \delta_m$. The closer the distance load to the power plant that supplies the value $\cos \delta_m$, the greater it will be because the difference of angle bus that sends and receives is smaller. The result will be worth the value of D and E will be smaller and greater value. The small value of D and the greater value of E results in the distance to $D = E$ or $d\Delta Q/dV = 0$ which becomes more distant. Therefore, this method can increase the steady-state stability limit [15].

2.2. Neural Network Algorithm

In the backpropagation algorithms, the desired and actual output of the neural network aims to adjust the network's weights in order to reduce the learning error. Specifically, a typical backpropagation algorithm consists of two passes: in the forward pass, the input vectors are presented to the network, and the actual outputs of the network are calculated. Then, the error between the actual and desired outputs is calculated. In the reverse pass, the error gradient with respect to the network's weights is calculated by propagating the error backwards through

the network. Once the error gradient is calculated, the weights are adjusted by using, for example, a descent gradient method.

In this paper, a backpropagation neural network is utilized to map the highly non-linear relationship between network voltage profile of load center from REI-Dimo Equivalent and the corresponding steady-state stability limit of power system. First, the simulation starts with running the power flow program for Java-Bali system. Then, by using REI- Dimo equivalent, the system will be reduced into simple network by reducing all load buses into a representative load center buses. Network voltage profile of reduced model is provided by REI-Dimo.

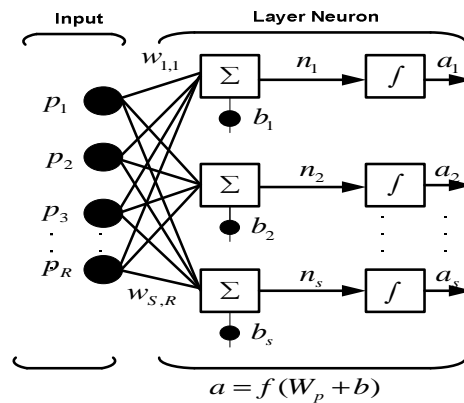

Figure 3. Architecture of ANN

The input pattern of steady-state stability is assessed by neural network (SSSANN). The number of input neurons of SSSANN is determined based on the size of the reduced model that obtained from REI-Dimo. There two output neurons which give the estimated SSSL. The number of hidden neurons is determined based on the trial and error. Generally, one of the drawbacks of neural network application in power system problems depends on its training on the power and load center voltage. Therefore, this dependency necessitates updating the training process in the case of any change in network parameter due to the increase of load center power. The input pattern of the proposed SSSANN is selected in such ways to obtain the representative of system. Therefore, in the case of load power change, network voltage profile, including the effect of network topology, load generation pattern, and reactive power compensation, remains as representative of system stability.

2.3 Structure of The Proposed Approach

Figure 4 shows the structure of the proposed approach. This approach consists of four main.

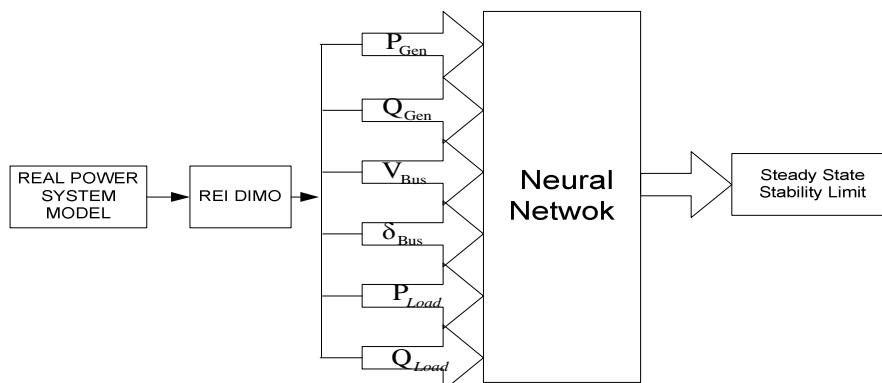

Figure 4. Scheme of research

The parts of the structure of the proposed approach are as follows: reducing the Java-Bali system be a simplify power system using REI- Dimo; determining the index steady-state stability limit using REI-Dimo; changing the power in the load center to obtain the parameter of system such as: real power and reactive power generation, magnitude and phase of bus voltage, D and E constant, and SSSL index. All data obtained from steps (3) will be used to train, validate and test the ANN; and evaluating index SSSL using ANN

Table 1. Line Data of 500 kV Java-Bali Power System

From Bus	To Bus	R (pu)	X(pu)	B (pu)
1	2	0,000626496	0,007008768	0
1	4	0,006513273	0,062576324	0,01197964
2	5	0,013133324	0,146925792	0,007061141
3	4	0,001513179	0,016928309	0
4	5	0,001246422	0,01197501	0
4	18	0,000694176	0,006669298	0
5	7	0,00444188	0,0426754	0
5	8	0,0062116	0,059678	0
5	11	0,00411138	0,04599504	0,008841946
6	7	0,001973648	0,01896184	0
6	8	0,0056256	0,054048	0
8	9	0,002822059	0,027112954	0
9	10	0,00273996	0,026324191	0
10	11	0,001474728	0,014168458	0
11	12	0,0019578	0,0219024	0
12	13	0,00699098	0,0671659	0,01285827
13	14	0,013478	0,12949	0,024789624
14	15	0,01353392	0,15140736	0,007276522
14	16	0,01579856	0,1517848	0,007264438
14	20	0,00903612	0,0868146	0
15	16	0,037539629	0,360662304	0,017261339
16	17	0,00139468	0,0133994	0
16	23	0,003986382	0,044596656	0
18	19	0,014056	0,157248	0,030228874
19	20	0,015311	0,171288	0,032927881
20	21	0,010291	0,115128	0,022131855
21	22	0,010291	0,115128	0,022131855
22	23	0,004435823	0,049624661	0,009539693

Table 2. Operating Condition

Bus No.	Load		Generation		Injected Mvar
	MW	Mvar	MW	Mvar	
1	153	45	3332.176	988.564	0
2	703	227	0	0	0
3	760	261	0	0	0
4	544	181	0	0	0
5	697	215	0	0	0
6	760	181	0	0	0
7	646	170	0	0	0
8	0	0	1470	679.361	0
9	823	317	0	0	0
10	680	245	400	484.322	0
11	0	0	535	1043.085	0
12	590	351	0	0	0
13	397	136	0	0	0
14	329	363	0	0	0
15	0	0	830	361.87	0
16	862	317	0	0	0
17	210	91	810	608.616	0
18	0	0	0	0	0
19	277	17	0	0	0
20	524	244	0	0	-158
21	358	206	0	0	-193
22	839	272	2820	895.043	-96
23	130	193	198	395.97	0
Total	10282	4032	10395.18	5456.832	-447

2.4. Test Power System

The Plant as the case for simulation is the 500 kV Java-Bali Power System as shown in Figure 5. The data of generator characteristics and cost, line impedances and an operating condition are shown at Tables 1-2.

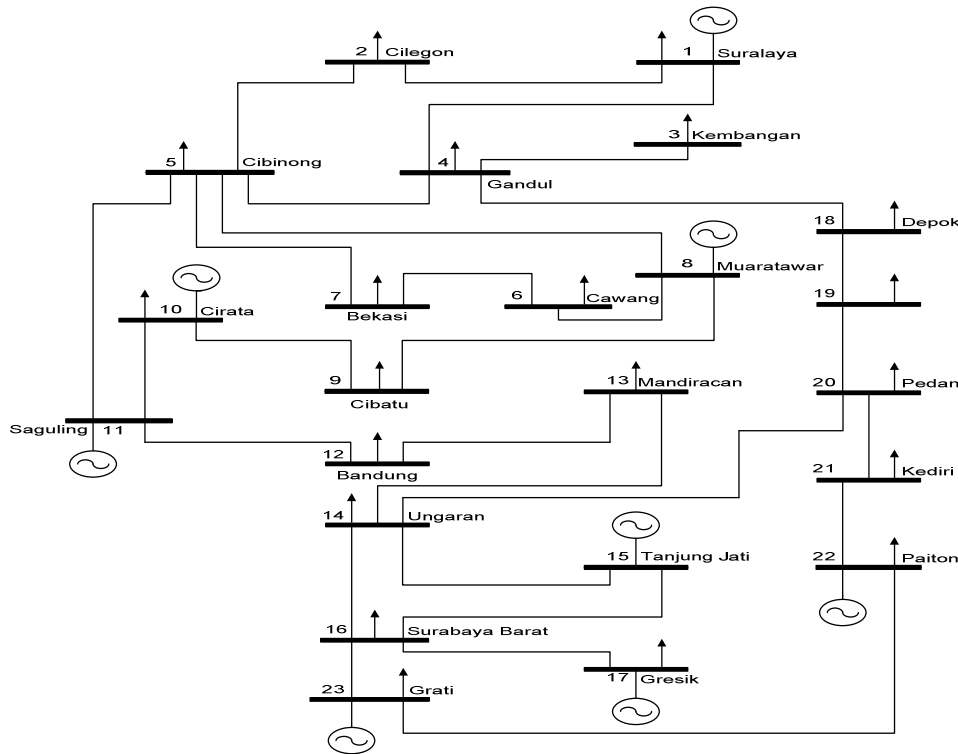

Figure 5. Single Line Diagram of 500 kV Java-Bali Power System

3. Results and Analysis

3.1 REI-Dimo Equivalent for Java-Bali System

Figure 6, shows the single load REI equivalent of Java Bali system with 8 generator bus and one load centre. The Y bus of equivalent system after Gaussian Elimination and REI-Dimo parameter are given in Table 3 and Table 4.

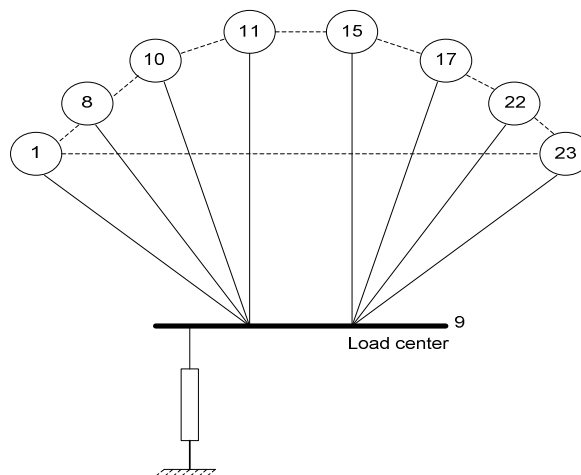

Figure 6. Single Load REI-Dimo of Java Bali System

Table 3. Y Bus of REI-Dimo Single Load Equivalent of Java Bali System

No Gen Bus	Bus 9 (Load Center)
1	-0.2296 - 2.7875i
8	-0.2282 - 2.5303i
10	-0.1732 - 1.8221i
11	0.0657 - 3.0665i
15	0.1065 - 0.6660i
17	0.0144 - 1.6252i
22	-0.0420 - 2.1648i
23	0.1672 - 0.6704i
9	0.3178 +15.2987i

Table 4. REI-Dimo Parameter

No Bus	Y re G (pu)	Y im B (pu)	REI MW	REI MVar	V (pu)	V ang($^{\circ}$)
1	-.2296	-.7875	3314.2	988.564	1.02	0
8	-.2282	-.5303	1470	679.361	1	-6.241
10	-.1732	-.8221	400	484.322	1	-7.029
11	0.0657	-.0665	535	1043.09	1	-6.663
15	0.1065	-0.666	830	361.87	1	9.938
17	0.0144	-.6252	810	608.616	1	9.735
22	-0.042	-.1648	2820	895.043	1	14.303
23	0.1672	-.6704	198	395.97	1	11.751
9	-0.637	-.0341	10264	4032	0.94	-4.267

The Java-Bali system changed into reduced model using REI-Dimo Method. Then using the equation (1), the steady-state stability limit of Java-Bali system was obtained. Figure 7 shows the value of SSSL of Java-Bali system using REI-Dimo.

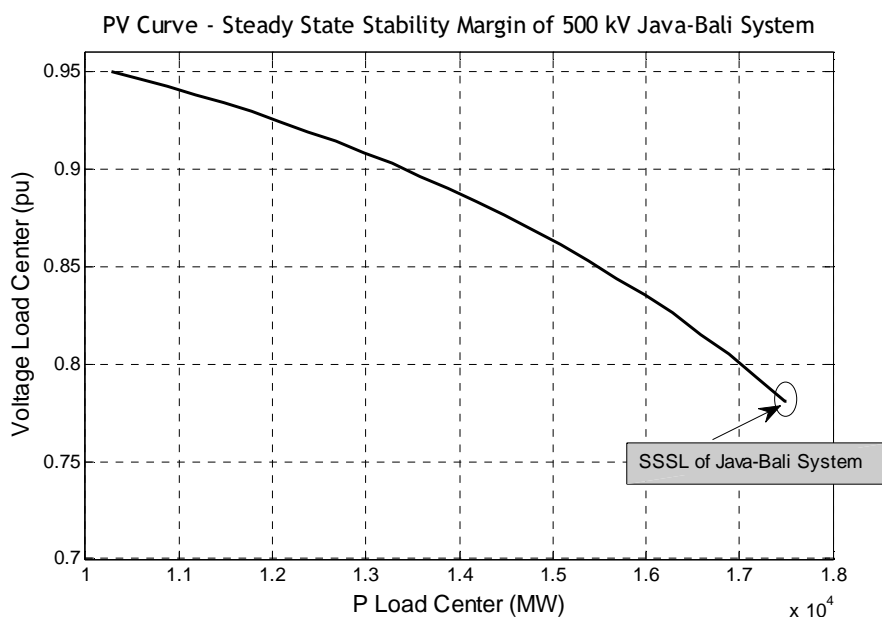

Figure 7. SSSL of Java-Bali System

3.2 Steady-state Stability Using ANN for Java-Bali power system

All data determined from REI-Dimo such as: active power generation (P_{Gen}), reactive power generation (Q_{Gen}), voltage of all bus, active load power and reactive load power will be input data and Voltage in the load center ($V_{load\ center}$), index of SSSL by REI-Dimo equivalent will be output data for ANN method. All data will be trained using backpropagation method with 5 layer neurons and 2 outputs.

Table 5. A few data that obtained from REI-Dimo

P_1	Q_1	V_1	Θ_1	...	P_{Load}	Q_{Load}	V_{Load}	Θ_{Load}	D	E	SSSL Index
1657.62	898.594	1.02	0	...	10282	4032	0.95	-26.7	61.07	120.7	-59.657
1905.77	969.249	1.02	0	...	10582	4148.14	0.946	-28.88	61.26	120.6	-59.294
2149.54	1046	1.02	0	...	10882	4265.74	0.942	-31.08	61.46	120.4	-58.895
2388.82	1128.7	1.02	0	...	11182	4383.34	0.938	-33.3	61.69	120.1	-58.458
2623.35	1217.23	1.02	0	...	11482	4500.94	0.934	-35.53	61.94	119.9	-57.98
2852.83	1311.47	1.02	0	...	11782	4618.54	0.929	-37.78	62.22	119.7	-57.456
3076.92	1411.29	1.02	0	...	12082	4736.14	0.924	-40.05	62.53	119.4	-56.883

Using REI-Dimo method, maximum voltage obtained in the load center ($V_{load(max)}$) area is 0.781 (pu) and the SSSL is -1.2376. All data obtained from REI-Dimo will be trained to ANN. Training process in NN needs epoch is 10, and obtained ($V_{load(max)}$) is 0.7807 (pu) and SSSL is 1.3111.

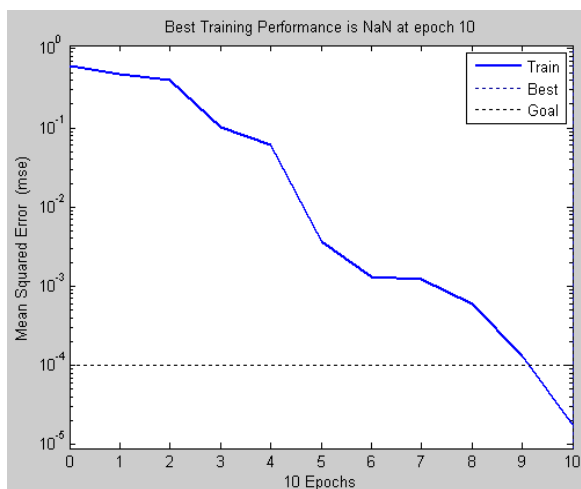

Figure 8. Training Performance

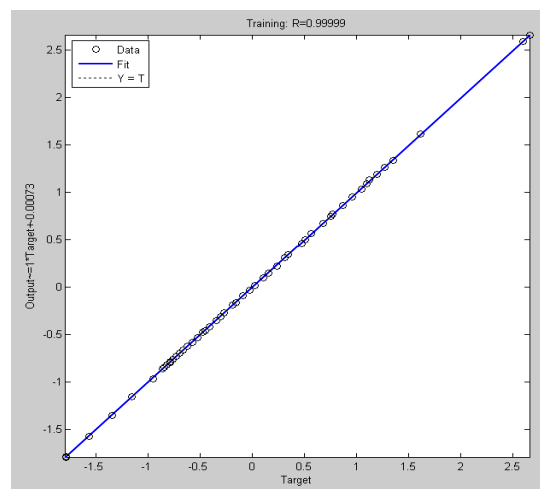

Figure 9. Regression Plot

To illustrate the effectiveness of the proposed ANN steady stability limit, the Java-Bali power system, shown in Figure 8 dan Figure 9, is considered. In addition to training, validating and testing errors, another post-training analysis denoted as a regression analysis has been performed, relating SSSANN response to the actual values to investigate the performance of the trained SSSANN. For this purpose, linear regression between SSSANN outputs and exact values is used to determine the accuracy of SSSANN. In table 6, the outputs of SSSANN are compare with the exact values that, while its $V_{load(max)}$ errors and SSSL errors are about 0.00038 and 0.05 respectively which are indicating good performance of SSSANN. Figure 10 and 11 show the estimated SSSL by SSSANN compared to the exact value of REI-Dimo method.

After training and testing SSSANN, it is used in the working mode of the proposed algorithm as shown in Table 7. In this mode, for any given operating point of power system by parameter measurement of bus voltages, voltage magnitudes and phase angles are extracted as input data to estimate SSSL by SSSANN.

As a case study, for an operating point with load center is 10640 MW and 4100.32 MVAR, the value of SSSL in Eq. (1) is taken as -59.4459 and two scenarios are studied in which all load center are supposed to be changed with 250 MW and 98 MVAR. Tables 8-9 show the result of load center change from 10460 MW to 11460 MW and 4100.32 MVAR to 4492.32 MVAR and load center voltage change from 0.948 (pu) to 0.934 (pu). The overall error in the output values for the given example is less than 0.5% which will be acceptable and the method has strong potential for steady-state stability assessment.

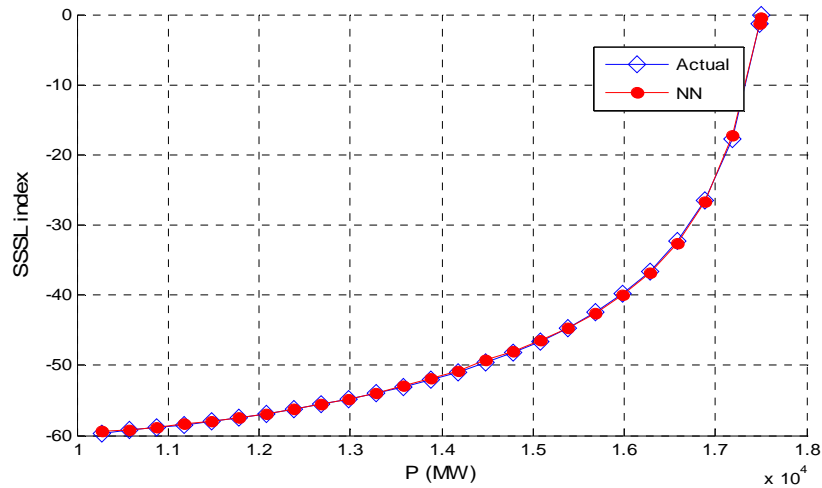

Figure 10. Comparison P vs Stability Index between REI-Dimo and ANN

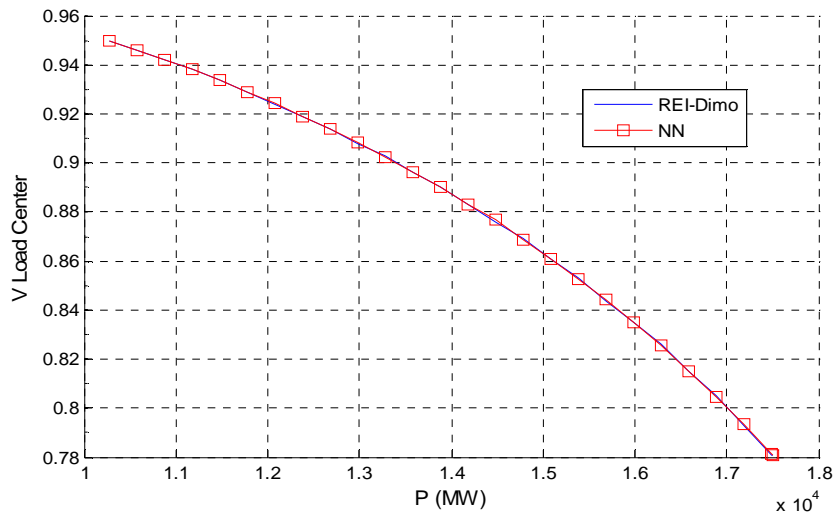

Figure 11. The Comparison P vs Stability Index between REI-Dimo and ANN

Table 6. The Comparison of REI-Dimo and ANN Result

No	Output	REI-Dimo	ANN Method	Error
1.	$V_{Load(max)}$	0.781	0.7807	0.00038
2.	SSSL	-1.2376	-1.2265	0.00897

Table 7. A few of Data Testing from REI-Dimo

P Load Center (MW)	Q Load Center (MVAR)	V Load Center (pu)	Θ Load Center (degree)	D	E	SSSL Index
10460	4100.32	0.948	-27.993	61.1773	120.6233	-59.4459
10710	4198.32	0.945	-29.819	61.342	120.47	-59.128
10960	4296.32	0.941	-31.656	61.521	120.31	-58.785
11210	4394.32	0.938	-33.504	61.714	120.13	-58.415
11460	4492.32	0.934	-35.365	61.924	119.94	-58.016

Table 8. The Comparison of Data Testing and Target for Index SSSL

No. Data	Data Testing	Data Target	Error
1	-59.1794	-59.4459	0.0045
2	-58.9366	-59.1280	0.0032
3	-58.6467	-58.7850	0.0024
4	-58.3024	-58.4150	0.0019
5	-58.3482	-58.0160	0.0057

Table 9. The Comparison of Data Testing and Target for Voltage Load

No. Data	Data Testing	Data Target	Error
1	0.9457	0.9480	0.0024
2	0.9428	0.9450	0.0023
3	0.9398	0.9410	0.0013
4	0.9366	0.9380	0.0015
5	0.9364	0.9340	0.0025

4. Conclusion

The estimated results obtained from ANN showed that this technique is able to predict the steady-state stability limit with a reasonable degree of accuracy. Since ANNs had high computation rates, parallel distributed processing, fault tolerance, and adaptive capability, they were excellent alternatives for real-time application combined with REI-Dimo method. The result showed that REI-Dimo and ANN had overall error in the output values was less than 0.5% which would be acceptable and it meant that the SSSANN method had strong potential for steady-state stability assessment. And by considering the training time and accuracy of the networks, it could be safely concluded that SSSANN was well-suited for online steady-state stability assessment of power systems.

Acknowledgments

The authors acknowledge the financial assistance granted by the Direktorat Jenderal Pendidikan Tinggi (DIKTI) – Hibah Guru Besar in support of this research project.

References

- [1] Savu C.Savulescu. Real-Time Stability Assessment in Modern Power System Control Center. IEEE Press. Wiley. 2009
- [2] Cornel Aldea, Savu C.Savulescu. Evaluation Of The Stability Reserve Of Transelectrica's Transmission System By Using Quickstab Professional. National Conference of Energy CNE. 2004
- [3] Ching-Yin Lee, ShaoHong Tsai, Yuan-Kang Wu. A New Approach to The Assessment os Steady-State Voltage Stability Margin Using P-Q-V Curve. *Electrical Power and Energy System*. 2010
- [4] Yang Wang, Wenyuan Li, Jiping Lu. A New Node Voltage Stability Index Based on Local Phasors. *Electrical Power and Energy System*. 2009; 79; 265-271
- [5] M.Moghavveni, M.O. Faruque. Power System Security and Voltage Collapse: A Line Outage Based Indicator for Prediction. *Electrical Power and Energy System*. 1999; 21; 455-461
- [6] Hiendro A. A Quantities Method of Induction Motor Under Unbalanced Voltage Conditions. *TELKOMNIKA Indonesian Journal of Electrical Engineering*. 2010; 8(2): 73-80.
- [7] Tumiran, Nandar CSA.Power Oscillation Damping Control using Robust Coordinated Smart Devices. *TELKOMNIKA Indonesian Journal of Electrical Engineering*. 2011; 9(1): 65-72.
- [8] M.H. Haque. A Fast Method for Determining The Voltage Stability Limit of a Power System. *Electrical Power and Energy System*. 1995; 32; 35-43
- [9] Savu C. Savulescu. Solving Open Access Transmission And Security Analysis Problem with The Short-Circuit Current Method. *Latin America Power Conference*, Mexico. 2002. Page: 1-5
- [10] B.Jeyasurya. Artificial Neural Network fo Power System Steady-State Voltage Instability Evaluation. *Electrical Power and Energy System*. 2010, 29: 85-90
- [11] Anna Larsson, Alain Germond, Boming Zhang. Application of Neural Networks to the Identification of Steady-state Equivalent of External Power Systems. *International Conference On Power System Technology*, Chongqing October 2006
- [12]. Ferdinando H, Pasila F, Kuswanto H. Enhanced Neuro-Fuzzy Architecture for Electrical Load Forecasting. *TELKOMNIKA Indonesian Journal of Electrical Engineering*. 2010; 8(2): 87-96.
- [13]. Nizam M. Kohonen Neural Network Clustering For Voltage Control In Power Systems. *TELKOMNIKA Indonesian Journal of Electrical Engineering*. 2010; 8(2): 116-122.

- [14]. Gupta M, Kumar R, Gupta RA. Neural Network Based Indexing and Recognition of Power Quality Disturbances. *TELKOMNIKA Indonesian Journal of Electrical Engineering*. 2011; 9(2): 227-236.
- [15] Savu C. Savulescu. Equivalent for Security Analysis of Power System. *IEEE Transactions on Power Apparatus and System*, 1981; 100(5) : 2672-2682